

Features

- Low-loss RF filter for digital television
- Ceramic Package for **Surface Mounted Technology (SMT)**
- Lead-free Production and **RoHS Compliance**

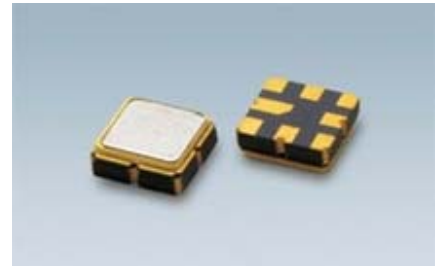

Package Dimensions

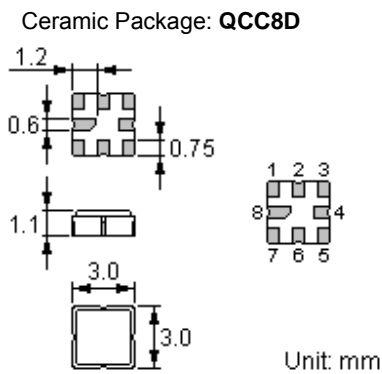

Pin Configuration

1, 2	Input
5, 6	Output
3, 7	To Be Grounded
4, 8	Case Ground

Marking



Top View, Laser Marking

- "ND": Manufacturer's mark
- "F": SAW filter
- "9253": Part number
- ".": Terminal 1
- "*": Lot number (The code shown below varies in a 4-year cycle)

Code	1	2	3	4	5	6	7	8	9	10	11	12
2011	a	b	c	d	e	f	g	h	i	j	k	m
2012	n	p	q	r	s	t	u	v	w	x	y	z
2013	A	B	C	D	E	F	G	H	J	K	L	M
2014	N	P	Q	R	S	T	U	V	W	X	Y	Z

Maximum Ratings

Rating	Value	Unit
Source Power	P	0 dBm
DC Voltage	V_{DC}	0 V
Operating Temperature Range	T_A	-40 ~ +85 °C
Storage Temperature Range	T_{stg}	-40 ~ +85 °C

Electrical Characteristics

Operating temperature range: $T = -40\text{ }^{\circ}\text{C} \dots +85\text{ }^{\circ}\text{C}$
 Terminating source impedance: $Z_S = 150\ \Omega$
 Terminating load impedance: $Z_L = 150\ \Omega$

Characteristic		Min.	Typ.	Max.	Unit
Nominal frequency	f_c	—	1280,18	—	MHz
Maximum insertion attenuation α_{max} 1260.18 ... 1300.18 MHz	IL	—	3,5	4,0	dB
Amplitude ripple (p-p) 1260.18 ... 1300.18 MHz	$\Delta\alpha$	—	0,5	1,0	dB
Pass bandwidth 1260.18 ... 1300.18 MHz	$\Delta\alpha$	—	0,5	1,0	dB
Relative attenuation (relative to α_{max})	α				
50.00 ... 1198.12 MHz		46.0	55.0		dB
1362.24 ... 2000.00 MHz		45.0	57.0		dB
2000.00 ... 6000.00 MHz		15.0	—		dB
Deviation from linear phase (rms) in any 30 MHz band 1260.18 ... 1300.18 MHz		—	4.5	6.0	$^{\circ}$
Group delay ripple (p-p) $\Delta\tau$ 1260.18 ... 1300.18 MHz		—	23.0	30.0	ns
Differential to common mode ratio ($ S_{dd21}/S_{cd21} $) 1260.18 ... 1300.18 MHz		9	11	—	dB

RoHS Compliant

Electrostatic Sensitive Device

Pin configuration

- 1/2 input
- 5/6 output
- 3,4,7,8

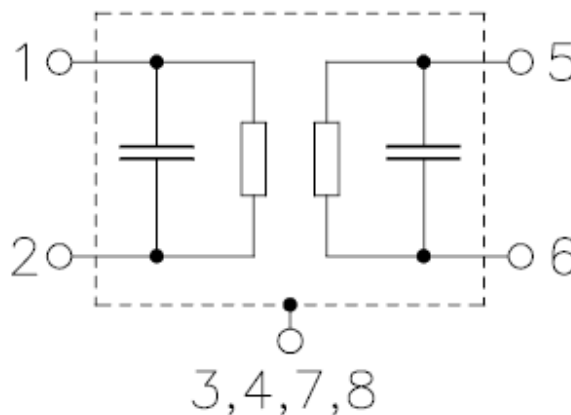

Typical Frequency Response

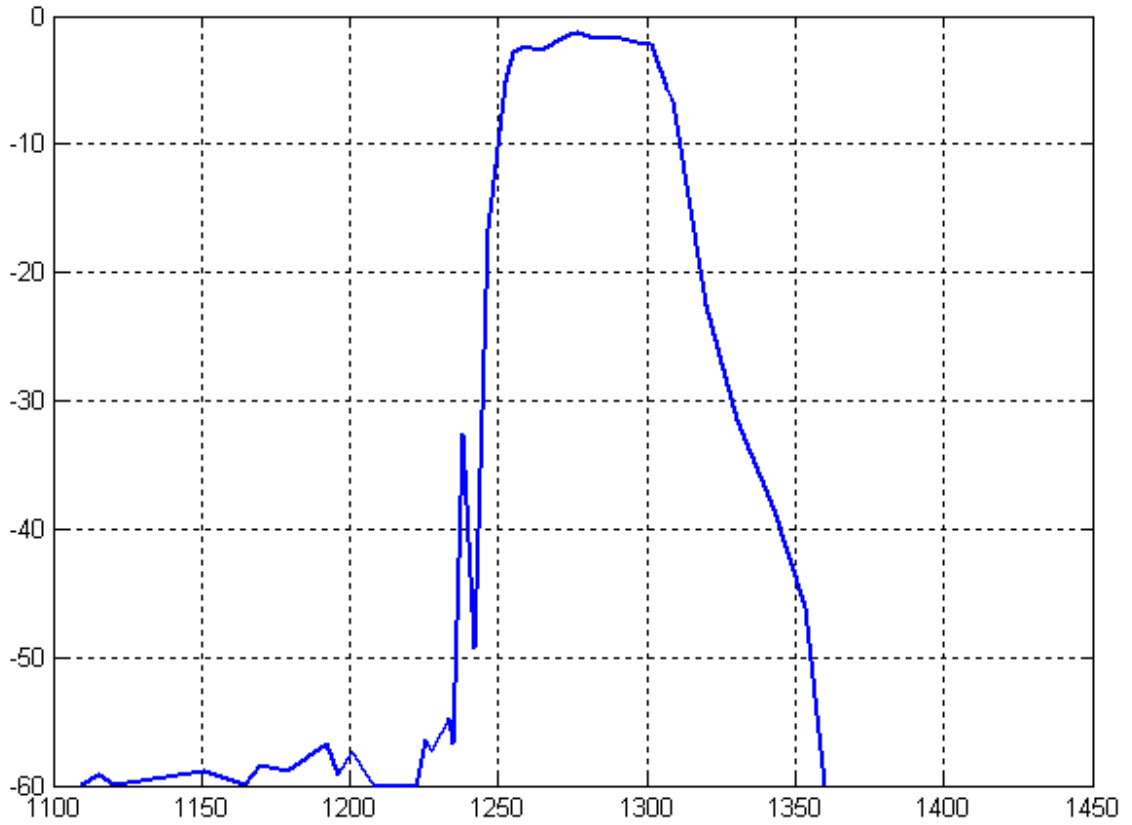

Stability Characteristics

	Test item	Condition of test
1	Mechanical shock	(a) Drops: 3 times on concrete floor (b) Height: 1.0 m
2	Vibration resistance	(a) Frequency of vibration: 10~55Hz (c) Directions: X,Y and Z (b) Amplitude: 1.5 mm (d) Duration: 2 hours
3	Moisture resistance	(a) Condition: 40°C, 90~95% R.H. (c) Wait 4 hours before measurement (b) Duration: 96 hours
4	Climatic sequence	(a) +70°C for 16 hours (c) -25°C for 2 hours (e) Wait 4 hours before measurement (b) +55°C for 24 hours, 90~95% R.H. (d) +40°C for 24 hours, 90~95% R.H.
5	High temperature exposure	(a) Temperature: 70°C (c) Wait 4 hours before measurement (b) Duration: 250 hours
6	Thermal impact	(a) +70°C for 30 minutes ⇒ -25°C for 30 minutes repeated 3 times (b) Wait 4 hours before measurement

Requirements: The SAW filter shall remain within the electrical specifications after tests.

Remarks

- SAW devices should not be used in any type of fluid such as water, oil, organic solvent, etc.
- Be certain not to apply voltage exceeding the rated voltage of components.
- Do not operate outside the recommended operating temperature range of components.
- Sudden change of temperature shall be avoided, deterioration of the characteristics can occur.
- Be careful of soldering temperature and duration of components when soldering.
- Do not place soldering iron on the body of components.
- Be careful not to subject the terminals or leads of components to excessive force.
- SAW devices are electrostatic sensitive. Please avoid static voltage during operation and storage.
- Ultrasonic cleaning shall be avoided. Ultrasonic vibration may cause destruction of components.

Equivalent LC Model

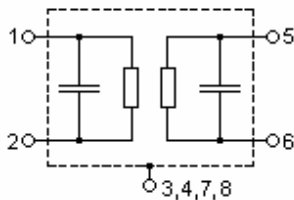

Recommended Land Pattern

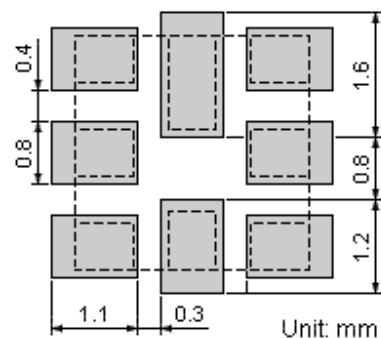

Packing Information

Carrier Tape

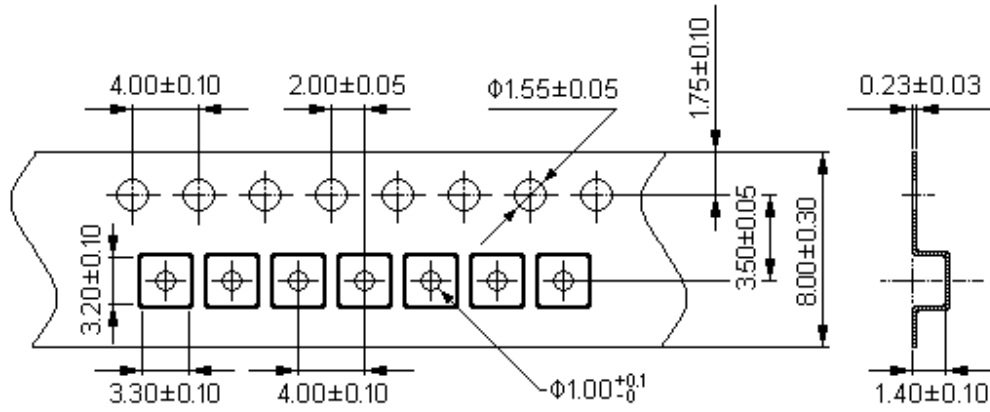

Dimensions in mm

Reel Dimensions

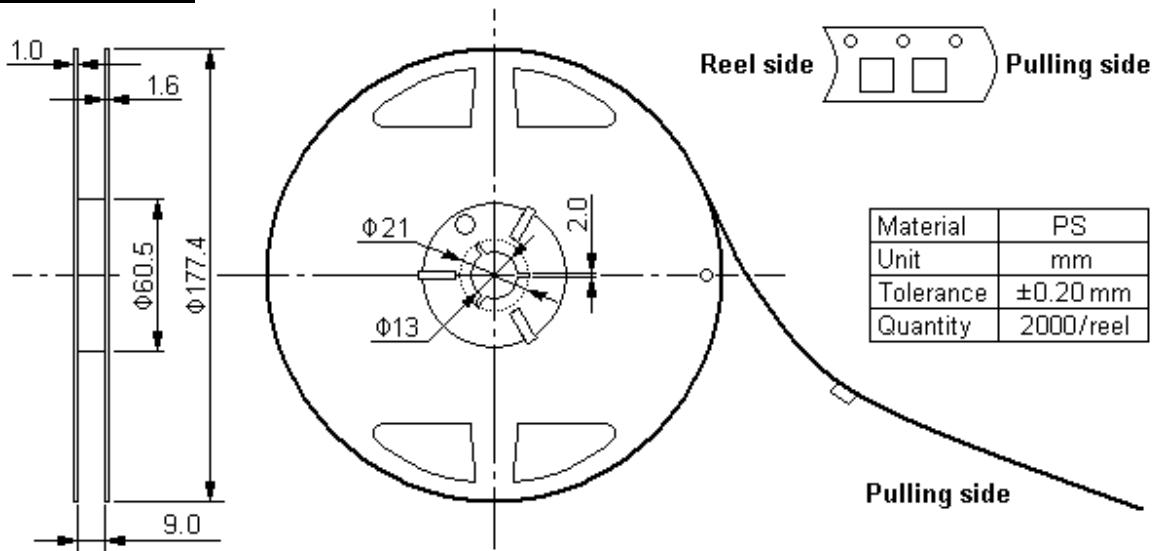

Outer Packing

Type	Quantity	Dimension	Description	Weight
Carton Box I	10000	190×190×95	anti-static plastic bag & carton box 1 reel / bag	0.85
Carton Box II	20000	190×190×190	5 bags / box (10000 pcs) 10 bags / box (20000 pcs)	1.70

Unit: mm

Unit: kg

Recommended Soldering Profile

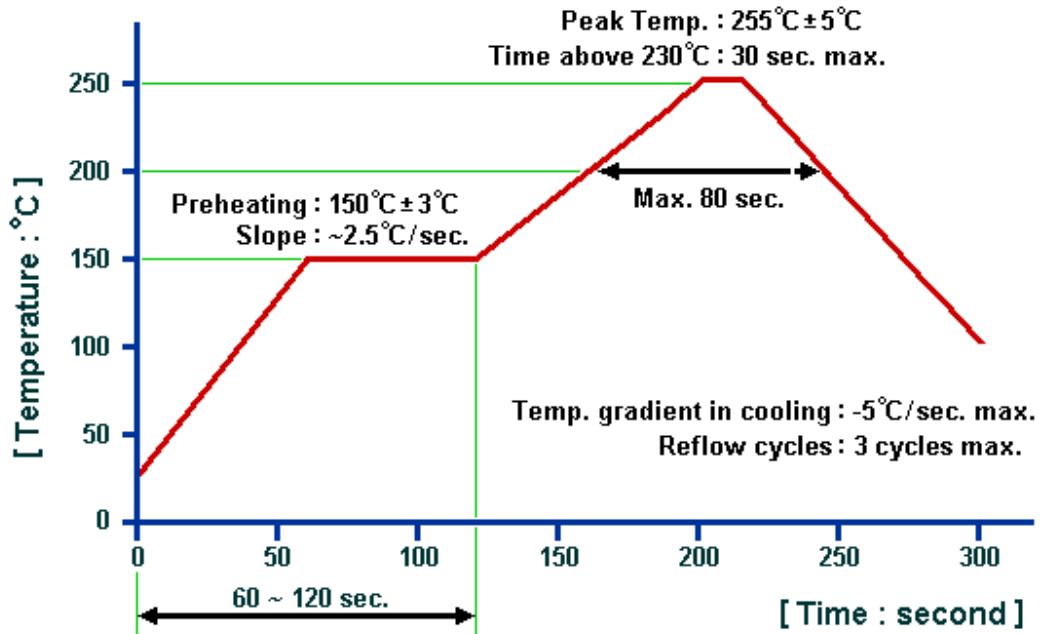

© NEDI 2011. All Rights Reserved.

1. The specifications of this device are subject to change or obsolescence without notice.
2. Typically, equipment utilizing this device requires emissions testing and government approval, which is the responsibility of the equipment manufacturer.
3. Our liability is only assumed for the Surface Acoustic Wave (SAW) component(s) per se, not for applications, processes and circuits implemented within components or assemblies.
4. For questions on technology, prices and delivery, please contact our sales offices or e-mail winnsky@winnsky.com